

# IC-M700TY

HF TRANSCEIVER

## INSTRUCTION MANUAL

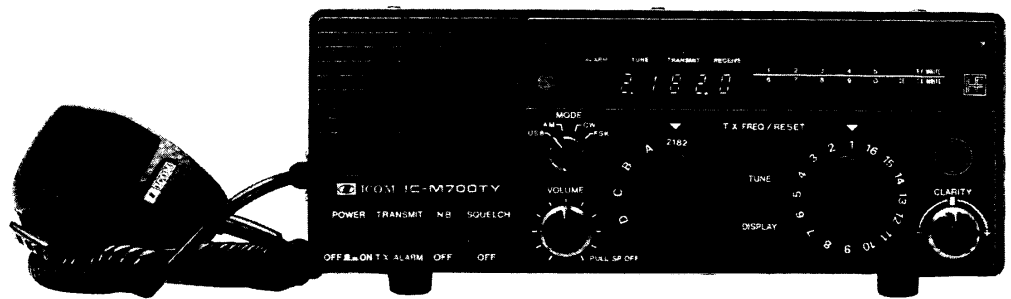

## FOREWORD

Congratulations for purchasing the ICOM IC-M700TY HF Transceiver.

ICOM uses the most advanced, state-of-the-art engineering concepts coupled with the latest technology when designing its communications products. Please read this instruction manual thoroughly prior to operating your new transceiver to become familiar with each of the features offered in the IC-M700TY.

## TABLE OF CONTENTS

SECTION	1	SPECIFICATIONS .....	1
SECTION	2	FEATURES .....	2
SECTION	3	INSTALLATION .....	3
SECTION	4	CONTROL FUNCTIONS.....	9
SECTION	5	OPERATING INSTRUCTIONS.....	12
SECTION	6	BLOCK DIAGRAM.....	16
SECTION	7	OPTIONS .....	17
SECTION	8	SCHEMATIC DIAGRAM.....	SEPARATE

ATTENTION: TRANSMITTING ALARM SIGNALS.....	15
--	----

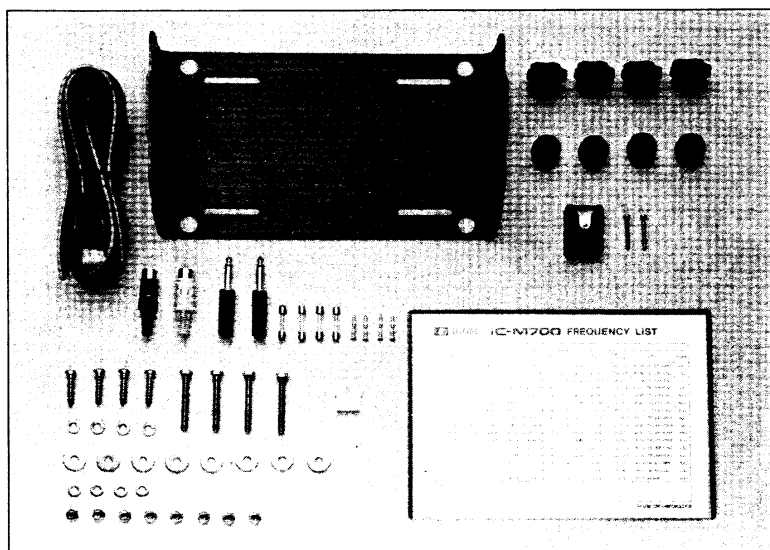

### IC-M700TY ACCESSORIES SUPPLIED

1. Power cable .....	1
2. External speaker plug .....	1
3. Key plug .....	1
4. Fuses (30A) .....	2
5. Fuses (5A) .....	2
6. Antenna tuner connector with 4 connector pins. ....	1
7. Mounting bracket .....	1
8. Bracket knobs .....	4
9. Flat washers (M5) .....	4
10. Bracket screws (self-tapping) .....	4
11. Bracket screws (hex head) .....	4
12. Flat washers (M6) .....	8
13. Spring washers (M6) .....	4
14. Bracket nuts (M6) .....	8
15. Microphone hanger .....	1
16. Microphone hanger screws .....	2
17. Frequency chart .....	1
18. Rubber feet .....	4
19. Accessory jack DIN connectors .....	2

## SECTION 1 SPECIFICATIONS

### GENERAL

Frequency coverage	: Receive : 1.6MHz ~ 23.9999MHz Transmit : 2.0MHz ~ 2.9999MHz 4.0MHz ~ 4.9999MHz 6.0MHz ~ 6.9999MHz 8.0MHz ~ 8.9999MHz 12.0MHz ~ 13.9999MHz 16.0MHz ~ 17.9999MHz 22.0MHz ~ 22.9999MHz
Frequency control	: CPU based 100Hz step digital PLL synthesizer. Independent transmit/receive frequency programmable on any band.
Frequency readout	: 6 digit 100Hz readout
Frequency stability	: Less than $\pm 10$ Hz in the range $-30^{\circ}\text{C} \sim +60^{\circ}\text{C}$
Memory channel capacity	: 64 simplex or semi-duplex channels (owner programmable)
Power supply requirements	: DC 13.6V $\pm 15\%$ (negative ground) Current drain 30A max. AC power supply available for AC operation.
Current Drain	: Receiving Standby : 1.2A Max. audio output : 1.6A Transmitting Maximum : 30A
Antenna impedance	: 50 ohms unbalanced
Weight	: 7.3kg (16.1 lb)
Dimensions	: 287(297)mm(W) x 112(124)mm(H) x 356(376)mm(D) Bracketed values include projections.

### TRANSMITTER

Emission modes	: J3E (A3J) USB, LSB H3E (A3H) AM A1A (A1) CW F1A (F1) FSK
RF output power	: 150W
Spurious emissions	: 65dB below peak power output.
Carrier suppression	: 50dB
Unwanted sideband	: $-55$ dB with 1000Hz AF input.
Microphone	: 600 ohm, noise cancelling microphone with push-to-talk switch.

### RECEIVER

Receive system	: Double conversion superheterodyne
Receive modes	: J3E (A3J) USB, LSB A3E (A3) AM A1A (A1) CW F1A (F1) FSK
Intermediate frequencies	: SSB, CW, FSK      1st                  2nd AM                    70.4515MHz      9011.5kHz 70.4500MHz      9010.0kHz
Sensitivity	: SSB, CW, FSK    0.5 $\mu$ V for 12dB SINAD AM                    2.0 $\mu$ V for 12dB SINAD
Selectivity	: SSB                2.3kHz/ $-6$ dB, 4.2kHz/ $-60$ dB AM                    6.0kHz/ $-6$ dB, 20.0kHz/ $-60$ dB CW, FSK*    0.5kHz/ $-6$ dB, 1.6kHz/ $-60$ dB
Spurious and image rejection	: 70dB
Clarity control range	: $\pm 150$ Hz
Audio output	: 5W into 4 ohms with 10% distortion
AF output impedance	: 2 ~ 8 ohms

\*Bandwidth for 170Hz shift FSK operation. Internal switches available for 425Hz and 850Hz shift FSK operation.  
See SECTION 3 - 11 FSK SETTINGS.

## SECTION 2 FEATURES

### ■ 64 MEMORY CHANNELS

The IC-M700TY can be operated simplex or semi-duplex on all channels. And, independent transmit and receive frequency programming in 100Hz steps provides complete flexibility.

Memories are fully programmable from the front panel keyboard, therefore programming can be done even in the field.

### ■ STABLE OPERATION

A quartz-locked, rock-solid, synthesized tuning system provides superb stability without ever having to purchase expensive crystals or PROMs. Frequency drift is minimal over the broad temperature range of  $-30^{\circ}\text{C}$  to  $+60^{\circ}\text{C}$  ( $-22^{\circ}\text{F}$  to  $140^{\circ}\text{F}$ ).

### ■ ALL MODES

Communication is possible using either SSB, AM, CW or FSK.

When operating CW, both full break-in and manual transmit/receive switching are available. SITOR operation is also possible due to the transceiver's rapid transmit/receive changeover time. Also, the IC-M700TY FSK mode can be set for 170Hz, 425Hz or 850Hz shift by means of internal switches.

### ■ FULL COVERAGE

The IC-M700TY features access to all HF channels in the range of 1.6MHz through 23.9999MHz as well as general coverage reception of UPI/AP news broadcasts, weather reports, WWV/CHU time signals, FAX weather charts and foreign broadcasts.

### ■ 100% DUTY CYCLE

A large, brushless DC fan provides ample cooling to allow the IC-M700TY to operate continuously with full output power.

### ■ EMERGENCY ALARM CIRCUIT

The IC-M700TY includes as standard equipment a circuit for transmitting the internationally recognized safety signal on 2182kHz during times of distress.

### ■ EXTRA FEATURES

Additional features include a wide-range clarifier, voice activated squelch (SSB, AM), carrier activated squelch (CW, FSK), noise blanker effective for both narrow and wide pulse noise, digital frequency readout, noise-cancelling microphone PLUS a heavy-duty mounting bracket. The IC-M700TY is also compatible with most existing antenna tuners by using the internal polarity switch and tuning power adjustment.

### ■ CONVENIENT OPTIONS

- AT-120 Automatic Antenna Tuner for rapid, easy matching of your transceiver to antenna for the most efficient operating conditions.

- Telephone-style handset for conversations requiring extra privacy.



## SECTION 3 INSTALLATION

### 3-1 UNPACKING

Carefully remove your transceiver from the packing carton and examine it for signs of shipping damage. Should any be apparent, notify the delivering carrier or dealer immediately, stating the full extent of the damage. It is recommended you keep the shipping cartons. In the event storage, moving or reshipping becomes necessary, they will be handy. Accessory cables, plugs, etc. are packed with the transceiver. Make sure you have not overlooked anything.

See the photo and description on the TABLE OF CONTENTS page at the front of this manual for accessory equipment included with the IC-M700TY.

### 3-2 PLANNING

Select a location for your transceiver which allows free access to the front controls, good air circulation and rear clearance for access to the cable connectors.

Avoid long cable runs to the antenna and power source. At the same time, keep power and antenna cables as far as possible from electrical sources, i.e. generators, alternators, electrical pumps, etc. Do not run the cables near magnetic compasses or electronic instruments.

### 3-3 MOUNTING THE TRANSCEIVER

Your IC-M700TY is supplied with a universal bracket which allows "over" or "under" mounting. Install the bracket to provide sufficient support for the transceiver.

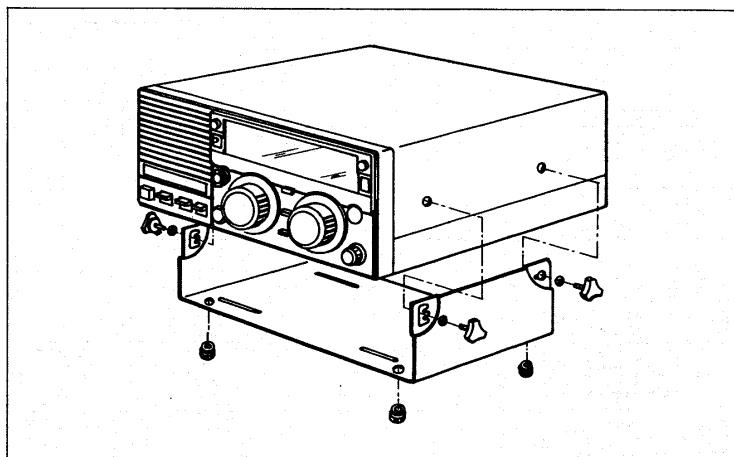

The mounting hardware supplied satisfies most installation requirements. If extra hardware is obtained, use only high quality material. Avoid drilling new mounting holes in the bracket as the transceiver balance may be affected.

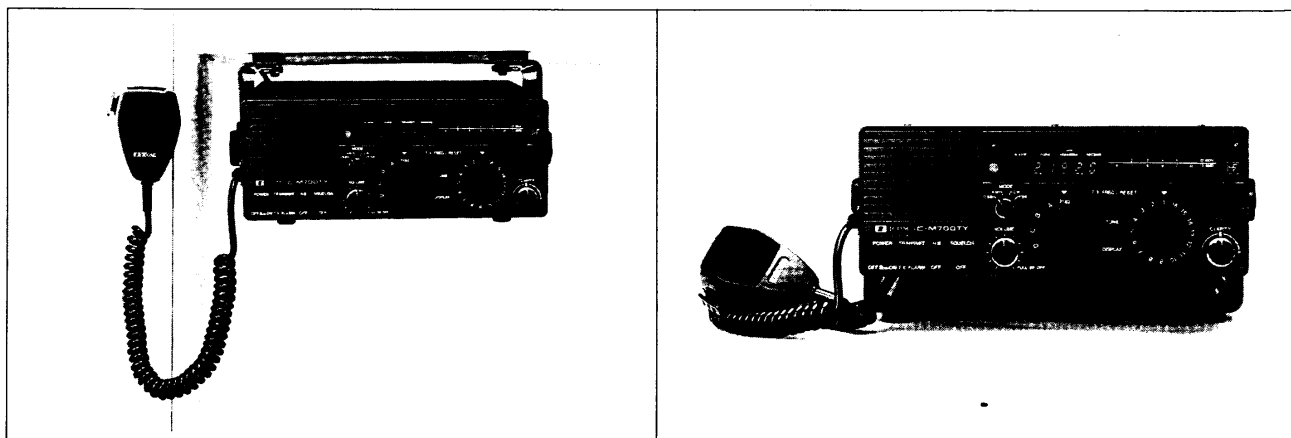

### 3-4 TYPICAL INSTALLATION

The diagram shows a typical installation. Any radio system operating with a whip antenna or single wire antenna must have an adequate ground connection otherwise the overall efficiency of the radio installation is degraded, especially at lower frequencies.

Using an antenna tuner in conjunction with a whip or long wire antenna provides an efficient installation suitable for all HF bands. The transceiver was designed to easily interface with most existing antenna tuners.

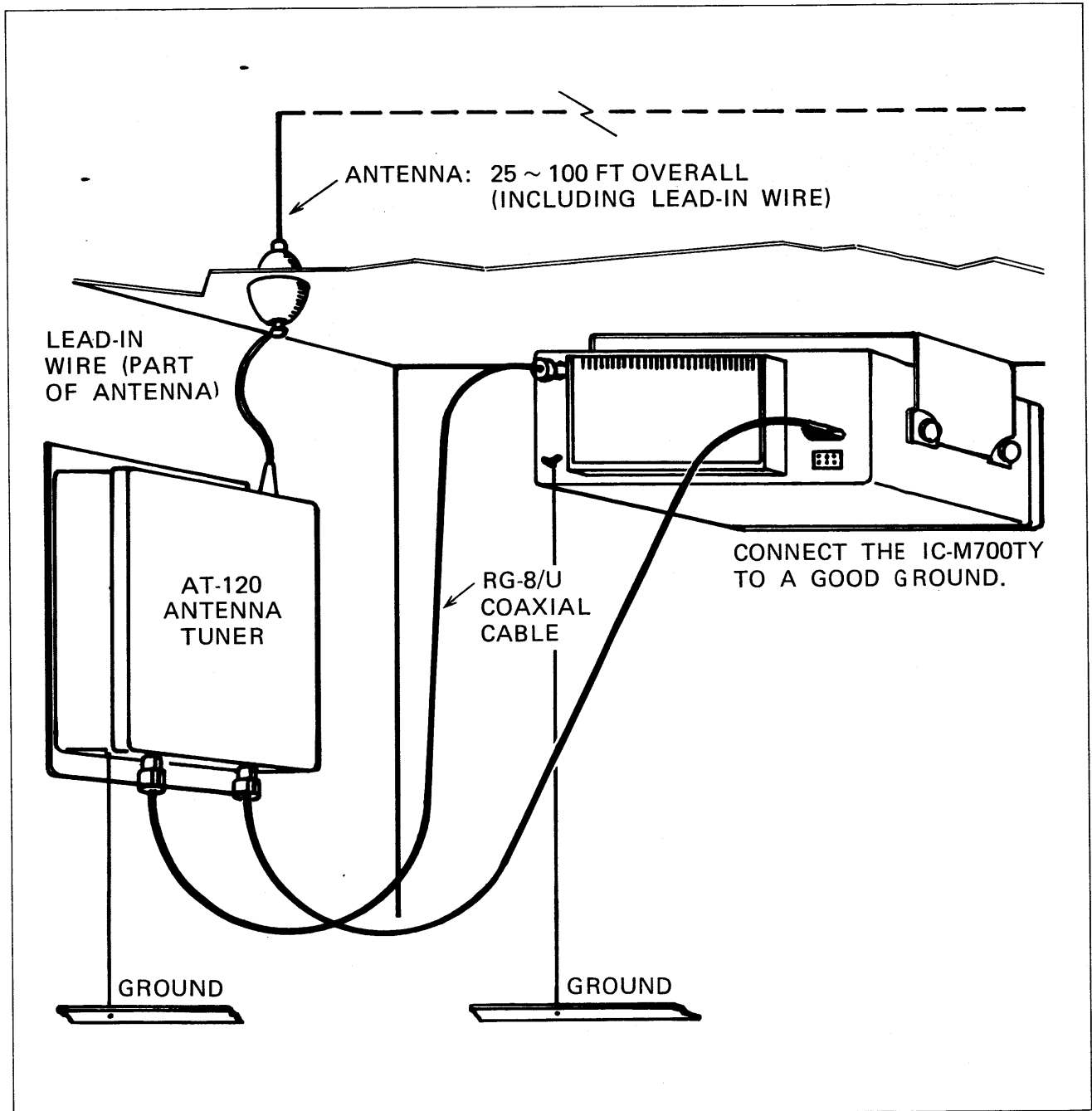

### 3-5 PRIMARY POWER

**CAUTION:** When using a power cable other than the cable supplied, always install a FUSE as close to the power source as possible.

If possible, do not use a power cable longer than 10 feet. For cable runs between 10 and 20 feet, use larger diameter #6 cable. Route the cable directly to the power source. Connect the RED lead to the positive terminal and the BLACK lead to the negative terminal of the DC power source. Solder all connections and ensure they are clean, tight and moisture-free.

Be sure to leave a service margin in the power cable for easy removal of the transceiver without straining the cable.

### 3 - 6 EXTERNAL SPEAKER



SP-15

The IC-M700TY contains an internal speaker but is designed to drive an external speaker from the external (EXT) speaker jack on the rear panel. Use a 4 ~ 8 ohm speaker, such as the optional SP-15, and the supplied 1/4 inch standard phone plug.

The external speaker is paralleled with the internal speaker and operates even if the internal speaker is turned OFF from the front panel. Thus, the external speaker jack can be used to supply AF output for a FAX machine.

### 3 - 7 CW KEY



For CW operation, connect a CW key to the CW KEY JACK using a 1/4 inch, 2-conductor plug. Observe the correct polarity of the leads as shown in the diagram when wiring.

### 3 - 8 ACCESSORY CONNECTORS

Refer to the following charts when connecting equipment to the IC-M700TY via the accessory connectors on the rear panel.

#### 3 - 8 - 1 ACC (1) CONNECTOR

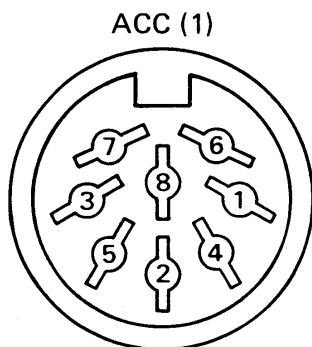

**NOTE:** Push OFF the POWER SWITCH on the front panel before connecting cables to the ACCESSORY CONNECTORS.

PIN	NAME	FUNCTION
1	F/C	Input for FSK keying.
2	GND	Ground. Connected in parallel with ACC (2) pin 2.
3	SEND	IC-M700TY switches to transmit mode when this pin is grounded.
4	MOD	Input to the modulator stage for AFSK or FAX (facsimile) operation. The modulator is activated by an 8V DC signal applied to ACC (1) pin 6.
5	AF	Output from the receiver detector stage. This is a fixed level regardless of the VOLUME setting or AF output.
6	MODS	Standard microphone is deactivated when 8V DC is applied to this pin. Apply external input via ACC (1) pin 4.
7	13.6V	13.6V DC output interlocked with the front panel POWER SWITCH. Maximum current rating is 1A. Connected in parallel with ACC (2) pin 7.
8	ALC	Input for external ALC voltage. Connected in parallel with ACC (2) pin 5.

#### 3 - 8 - 2 ACC (2) CONNECTOR

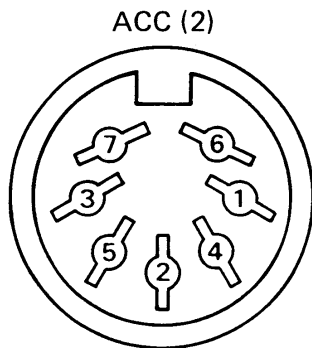

PIN	NAME	FUNCTION
1	8V	8V DC output (less than 100mA).
2	GND	Ground. Connected in parallel with ACC (1) pin 2.
3	SEND	IC-M700TY switches to the transmit mode when this pin is grounded.
4	2M	When operating 1.6 ~ 2.9999MHz, 8V DC is output to deactivate a linear amplifier.
5	ALC	Input for external ALC voltage. Connected in parallel with ACC (1) pin 8.
6	RL	T/R switch for external equipment. The relay is grounded when transmitting. Maximum values: 50V, 0.5A, 10W.
7	13.6V	13.6V DC output interlocked with the front panel POWER SWITCH. Connected in parallel with ACC (1) pin 7.

### 3-9 ANTENNA TUNER

#### ■ SETTINGS (SWITCHES S1, S2)

##### AT-120 ANTENNA TUNER USERS:

The IC-M700TY is shipped with SWITCH S1 and SWITCH S2 both set at the "2" positions. These are the correct settings for use with the AT-120, and no further adjustments are necessary.

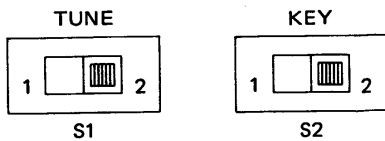

**NOTE:** "BEFORE/AFTER TUNING" and "WHILE TUNING" refer to the tuning action of an external automatic antenna tuner.

#### ■ TUNING POWER ADJUSTMENT

**NOTE:** This adjustment is not necessary when using the AT-120.

The IC-M700TY is equipped with an antenna tuner connector which feeds out and accepts control signals for control of an automatic antenna tuner. The control signal levels are selected by internal switches, therefore most antenna tuners presently available may be used.

Select the correct antenna tuner switch settings for your particular tuner using the charts.

- Remove top cabinet cover.
- S1 and S2 are located in the lower left corner of the MAIN circuit board.

##### SWITCH S1: TUNE SWITCH

	SWITCH POSITION	ANTENNA CONNECTOR "START" TERMINAL
BEFORE/AFTER TUNING	1	GROUNDED BY IC-M700TY
	2	8V DC FROM IC-M700TY
WHILE TUNING	1	8V DC FROM IC-M700TY
	2	GROUNDED BY IC-M700TY

##### SWITCH S2: KEY SWITCH

	SWITCH POSITION	ANTENNA CONNECTOR "KEY" TERMINAL
BEFORE/AFTER TUNING	1	0V
	2	8V DC FROM IC-M700TY
WHILE TUNING	1	2V ~ 15V FROM TUNER
	2	GROUNDED BY TUNER

When no antenna tuner is connected, the TUNE SWITCH on the front panel does not function.

This preset adjustment must be performed so the antenna tuner receives the correct tuning power level from the IC-M700TY.

The adjustment is factory set for 10 watts but it is variable from 5 to 20 watts.

- ① Remove the top cabinet cover.
- ② Ground CP15 on the MAIN circuit board.
- ③ Ground CP30 on the MAIN circuit board. This turns ON the tuning power.
- ④ Adjust R19 on the RF circuit board for twice the output power required by your antenna tuner.
- ⑤ Remove the ground from CP15.
- ⑥ Adjust the TUNING POWER ADJUSTMENT, R247 on the MAIN circuit board for the output power required by your antenna tuner.
- ⑦ Remove the ground from CP30.



**IC-M700TY TOP VIEW  
(MAIN BOARD)**

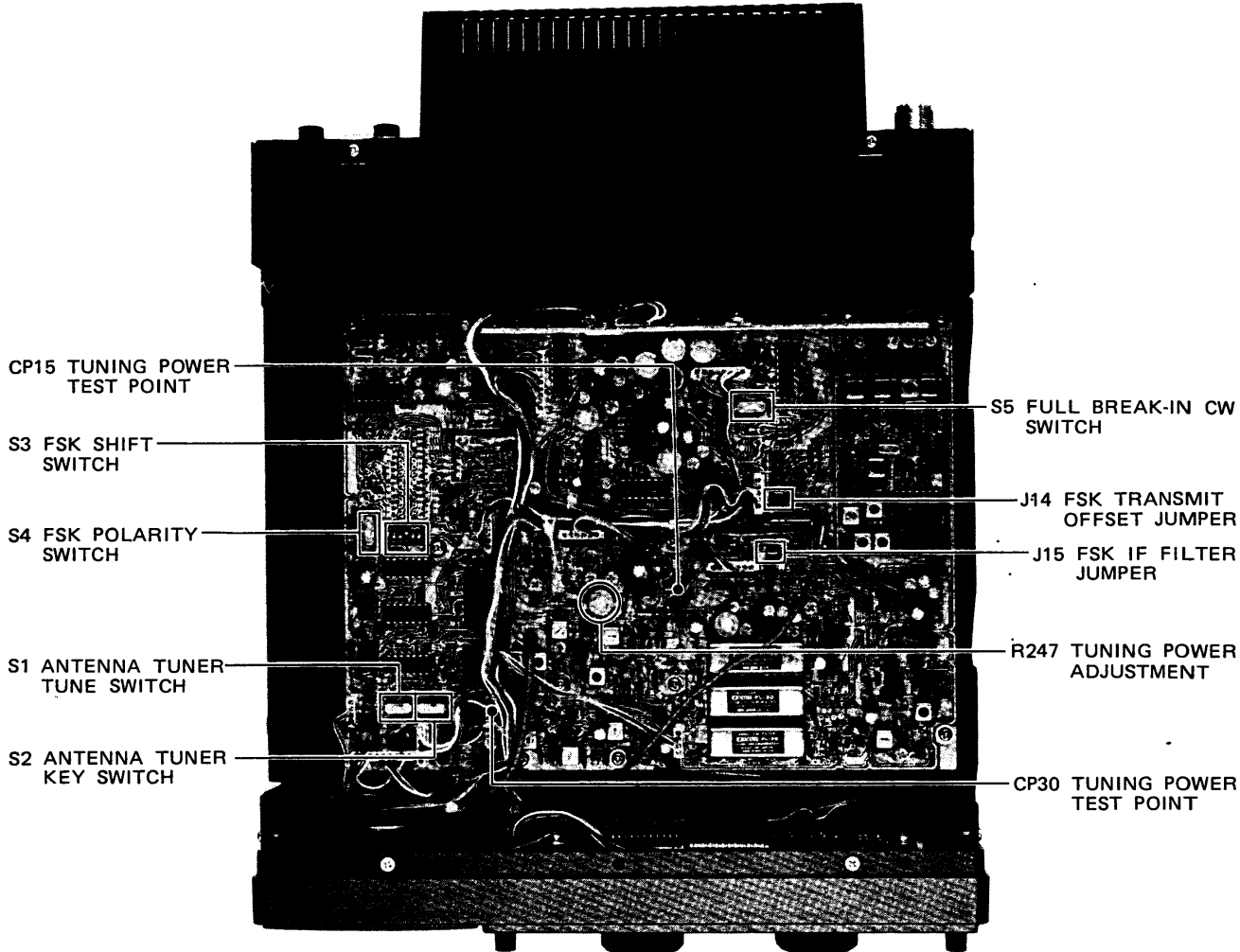

**IC-M700TY SIDE VIEW  
(RF BOARD)**

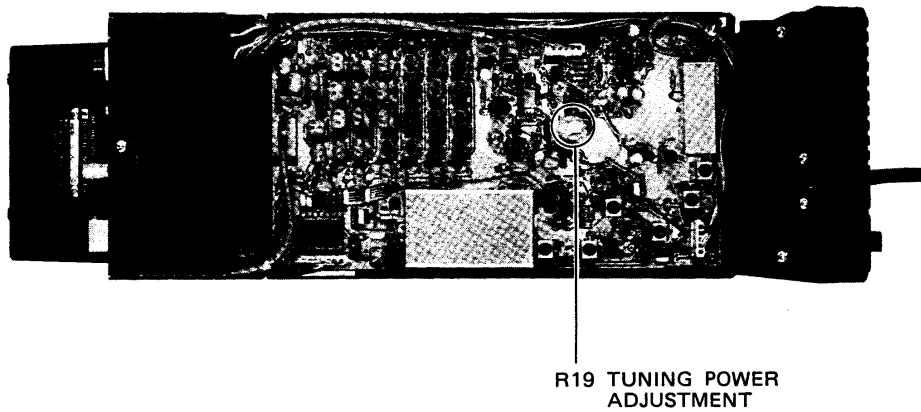

### 3 - 10 CW SETTINGS

#### ■ MANUAL/FULL BREAK-IN (SWITCH S5)

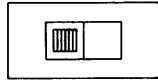

→ FULL BREAK-IN

S5 factory setting.  
(MANUAL)

Either FULL BREAK-IN or MANUAL CW operation may be selected by SWITCH S5 on the MAIN circuit board.

- Remove the top cabinet cover from the IC-M700TY.
- Locate SWITCH S5 in the upper right corner of the MAIN circuit board.
- Select either FULL BREAK-IN as indicated by the arrow on the circuit board or MANUAL by moving SWITCH S5 in the opposite direction.

**NOTE:** FULL BREAK-IN operation refers to transmit/receive switching performed automatically by the transceiver in unison with the closing and opening of the CW key. MANUAL operation requires the operator to select the transmit or receive mode.

### 3 - 11 FSK SETTINGS

**NOTE:** The IC-M700TY is shipped ready for use with the standard 170Hz shift frequency.

Four settings must be performed before the FSK mode may be used.

- FSK shift frequency
- FSK polarity
- FSK IF filter selection
- FSK transmit offset

Remove the top cabinet cover and use the photograph and charts to set each of these parameters.

#### ■ FSK SHIFT (SWITCH S3)

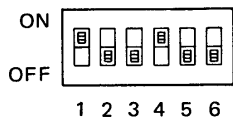

S3 factory setting.

FSK SHIFT (Hz)	SWITCH S3 SETTINGS					
	1	2	3	4	5	6
170	ON	OFF	OFF	ON	OFF	OFF
425	OFF	ON	OFF	OFF	ON	OFF
850	OFF	OFF	ON	OFF	OFF	ON

#### ■ FSK POLARITY (SWITCH S4)

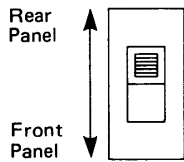

S4 factory setting.

SWITCH S4	ACC (1) pin 1 condition	
	HIGH level or KEY UP	LOW level or KEY DOWN
Towards REAR PANEL	Low frequency (MARK)	High frequency (SPACE)
Towards FRONT PANEL	High frequency (SPACE)	Low frequency (MARK)

#### ■ FSK IF FILTER (JUMPER J15)

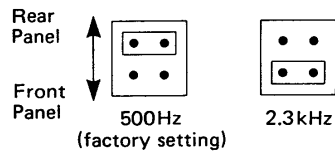

500Hz (factory setting)



2.3kHz

FSK SHIFT (Hz)	IF FILTER WIDTH (J15)
170	500Hz
425	2.3kHz
850	2.3kHz

#### ■ FSK TRANSMIT OFFSET (JUMPER J14)

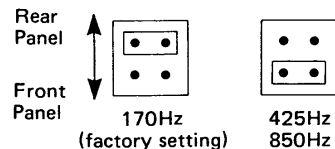

170Hz (factory setting)



425Hz  
850Hz

The position of jumper J14 must be changed if a shift frequency of either 425Hz or 850Hz is used. This is necessary to keep the front panel display frequency accurately calibrated.

## SECTION 4 CONTROL FUNCTIONS

### 4-1 FRONT PANEL

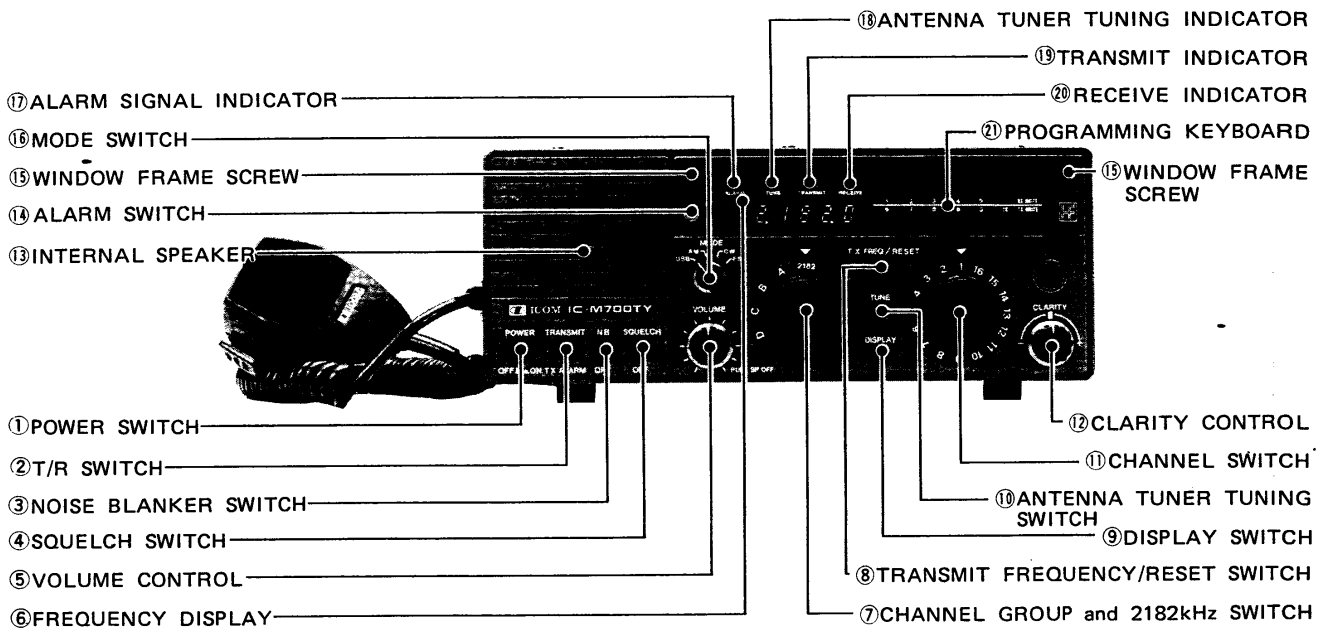

#### ① POWER SWITCH

A push-lock switch which controls the input DC power to the IC-M700TY.

- Push once to turn the transceiver ON. Power is applied to the set.
- Push again and release to turn the transceiver OFF. Power is removed from all circuits except the PA unit.

#### ② T/R SWITCH

Switches the IC-M700TY between the transmit and receive modes.

- Push the switch upwards to transmit.
- Place the switch in the center to receive.
- Hold the switch downwards and push IN the ALARM SIGNAL SWITCH to transmit a distress signal on 2182kHz.

#### ③ NOISE BLANKER SWITCH

Switches the noise blanker circuit ON and OFF.

- Push the switch upwards to reduce "woodpecker" type pulse noise interfering with reception.

#### ④ SQUELCH SWITCH

Switches the squelch function ON and OFF.

- Push the switch upwards to quiet the noise from the speaker when no signal is being received.

#### ⑤ VOLUME CONTROL

Controls the audio output level in the receive mode.

- Turn the control clockwise to increase the audio level.
- Pull the control outwards to disconnect the internal speaker (for FAX operation for example). This does not disconnect the external speaker.

- ⑥ FREQUENCY DISPLAY** Shows the operating carrier frequency (receive or transmit) of the selected channel.
- ⑦ CHANNEL GROUP and 2182kHz SWITCH** Selects channel group A, B, C or D. Each group has 16 channels for a total of 64 channels. Use the CHANNEL SWITCH to select a specific channel within a group. Also selects 2182kHz with the AM mode automatically. Refer to item ⑧ below.
- ⑧ TRANSMIT FREQUENCY/ RESET SWITCH** The frequency readout displays the transmit frequency of the selected channel while this switch is held IN. Also, resets the IC-M700TY after using the alarm function (see SECTION 5 - 3) or after selecting 2182kHz with switch ⑦. After resetting, use the MODE SWITCH to select the mode required.
- ⑨ DISPLAY SWITCH** Turns all front panel display illuminations ON or OFF.
- ⑩ ANTENNA TUNER TUNING SWITCH** Starts the automatic tuning function of the ICOM AT-120 Antenna Tuner (optional) or other compatible tuner. See SECTION 5 - 2 - 2 RECEIVING for more information.
- ⑪ CHANNEL SWITCH** Selects 1 of the 16 channels within each channel group. Select the desired channel group with the CHANNEL GROUP SWITCH.
- ⑫ CLARITY CONTROL** Shifts the receive frequency by up to 150Hz either side of the displayed receive frequency.  
 ● Turn clockwise (+ direction) to raise the receive frequency.  
 ● Center the control to receive the exact receive frequency displayed.  
 ● Turn counterclockwise (– direction) to lower the receive frequency.
- ⑬ INTERNAL SPEAKER** The IC-M700TY delivers up to 5 watts of audio power to this speaker for clear, easy-to-understand reception. The audio to this speaker may be disconnected by pulling OUT the VOLUME CONTROL.
- ⑭ ALARM SWITCH** Activates the emergency alarm function which sends a distress signal on 2182kHz. See SECTION 5 - 3 ALARM FUNCTION for more information.
- ⑮ WINDOW FRAME SCREWS** Remove these screws and lift off the frequency display window to gain access to the memory programming keyboard.
- ⑯ MODE SWITCH** Selects one of the operating modes:  
 ● USB (Upper Sideband).  
 ● AM (Amplitude Modulation).  
 ● CW (Continuous Wave Telegraphy).  
 ● FSK (Frequency Shift Keying).  
 Turn the switch fully counterclockwise to select the LSB (Lower Sideband) mode.
- ⑰ ALARM SIGNAL INDICATOR** Illuminates while the 2182kHz alarm circuit sends the distress signal.
- ⑱ ANTENNA TUNER TUNING INDICATOR** Illuminates while the AT-120 Automatic Antenna Tuner (optional) or similar tuner is in operation. Extinguishes when tuning is complete.
- ⑲ TRANSMIT INDICATOR** Illuminates while the IC-M700TY is in the transmit mode.
- ⑳ RECEIVE INDICATOR** Illuminates when the squelch is open in the receive mode.
- ㉑ PROGRAMMING KEYBOARD** Used to program the receive and transmit frequency for each of the 64 channels.

## 4-2 REAR PANEL

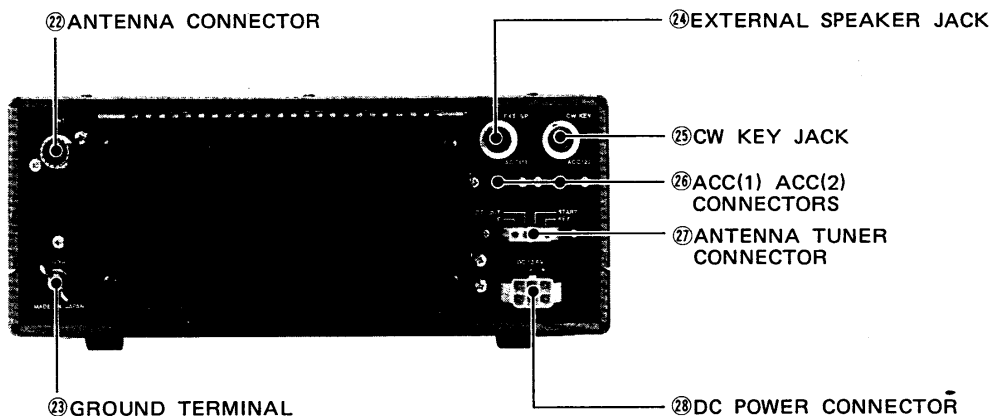

### 22 ANTENNA CONNECTOR

Connect an antenna to the IC-M700TY here. Use a 50 ohm antenna with a PL-259 connector on the feedline. When using a whip antenna or single wire antenna, use an antenna tuner for matching the antenna with the transceiver.

### 23 GROUND TERMINAL

To prevent electrical shocks, interference to other electronic equipment and other problems, ground the transceiver to a good ground through the GROUND TERMINAL. For best results, use a heavy gauge wire or strap, and make the connection as short as possible.

### 24 EXTERNAL SPEAKER JACK

Connect an external speaker, when required, to this jack. Use a speaker with an impedance of 4 ~ 8 ohms. The external speaker is in parallel with the internal speaker, but is not affected by the front panel SPEAKER OFF SWITCH. Suitable for connecting a FAX machine.

### 25 CW KEY JACK

Connect a CW key for telegraphy operation. Use a standard 1/4", 2-conductor plug.

### 26 ACC(1), ACC(2) CONNECTORS

Useful for various control functions and for operating FSK. See SECTION 3 - 8 ACCESSORY CONNECTORS for detailed information.

### 27 ANTENNA TUNER CONNECTOR

Connect an antenna tuner, such as the AT-120 Automatic Antenna Tuner, to this connector, if required. Tuning signals are input and output at this connector, and 13.6V DC is supplied for tuner operation.

### 28 DC POWER CONNECTOR

Connect a 13.6V DC, 30A power source.

## SECTION 5 OPERATING INSTRUCTIONS

### 5 - 1 PROGRAMMING THE CHANNELS

Follow the procedure below to store or change a frequency in any of the memory channels.

- ① Select a channel.
  - ② Remove the WINDOW FRAME.
  - ③ Enter the desired receive frequency.
  - ④ Push the "RX WRITE" key.
  - ⑤ Enter the desired transmit frequency.
  - ⑥ Memorize all receive/transmit frequency combinations in the same way.
- ① Use the CHANNEL GROUP and CHANNEL SWITCHES to select a channel. If no frequency has been memorized, only the MHz and kHz decimal points light.
  - ② Remove the WINDOW FRAME SCREWS and WINDOW FRAME.
  - ③ Enter the desired receive frequency using the KEYBOARD. Begin with the 10MHz digit (or 1MHz digit for frequencies lower than 10.000MHz) and enter all digits consecutively.
    - If an out-of-band frequency (a frequency outside the tuning limits of the transceiver) is entered, all digits are cancelled, and the display is blanked. Only the MHz and kHz decimal points remain lit.
    - If an error is made when entering the frequency, push the "CE" key. The entered digits are cancelled, and the previously memorized frequency is recalled.
  - ④ When all digits are entered correctly, push the "RX WRITE" key. The receive frequency is now memorized in the selected channel.
  - ⑤ If the desired receive and transmit frequencies are identical, push the "RX WRITE" and "TX WRITE" keys simultaneously.
    - Note that the receive frequency must be stored first before the transmit frequency.
    - When the receive and transmit frequencies differ, repeat step ③ to enter the transmit frequency. Push the "TX WRITE" key.
    - Push the TRANSMIT FREQUENCY/RESET SWITCH to view the memorized transmit frequency on the display.
    - Enter "0" for the transmit frequency when only a receive frequency is desired for a particular channel.
  - ⑥ Memorize receive and transmit frequencies for each channel required in a similar manner.

**EXAMPLE:** Memorize 2345.6MHz.

Memorize transmit frequency 13210.5kHz.  
(When transmit frequency differs from receive frequency.)

Push key	Display	
	12.357.0	(Previous frequency)
2	. . 2	
3	. 2.3	
4	. 23.4	
5	. 234.5	
6	2.345.6	
RX WRITE	2.345.6	(Receive frequency memorized in the selected channel.)
RX WRITE	2.345.6	(Receive and transmit frequency memorized in the selected channel.)
TX WRITE		

(Push both keys together.)

Push key	Display	
	2.345.6	(Receive frequency)
1	. . 1	
3	. 1.3	
2	. 13.2	
1	. 132.1	
0	1.321.0	
5	13.210.5	
TX WRITE	2.345.6	Push the TRANSMIT FREQUENCY/RESET SWITCH to see the transmit frequency.

## 5 - 2 OPERATION

### 5 - 2 - 1 CHANNEL SELECTION

- ① Select the desired channel group: A, B, C or D.
- ② Select the desired channel: 1 ~ 16.

### 5 - 2 - 2 RECEIVING

- ① Set the front panel controls.

The following section explains how to receive and transmit with your IC-M700TY.

- ① Use the CHANNEL GROUP SWITCH to select either group A, B, C or D which contains the channel you wish to operate on.
  - Each group contains a maximum of 16 programmed channels for a total of 64 available channels.

- ② Use the CHANNEL SWITCH to select the exact channel (1 through 16) desired within group A, B, C or D.

- ① After connecting power, an antenna, etc., to the transceiver as explained in SECTION 3 INSTALLATION, set the controls as below:

CONTROL	SETTING
POWER SWITCH	OFF (OUT)
T/R SWITCH	RECEIVE (CENTER)
NOISE BLANKER SWITCH	OFF (DOWN)
SQUELCH SWITCH	OFF (DOWN)
VOLUME CONTROL	MINIMUM (COUNTERCLOCKWISE) SPEAKER ON (IN)
MODE SWITCH	Desired Mode
CHANNEL GROUP SWITCH	Desired Group
CHANNEL SWITCH	Desired Channel
DISPLAY SWITCH	ON (OUT)
CLARITY CONTROL	CENTER (DETENT)

- ② Push IN the POWER SWITCH.
- ③ Adjust the VOLUME CONTROL.
- ④ Push the TUNE SWITCH when using an antenna tuner.
- ⑤ Turn ON the SQUELCH to quiet vacant channels.
- ⑥ Adjust the CLARITY CONTROL.
- ⑦ Turn ON the NOISE BLANKER to reduce pulse noise.
- ⑧ Pull OUT the VOLUME CONTROL when operating FSK.
- ⑨ Push the DISPLAY SWITCH to extinguish the front panel illuminations.

- ② Push IN the POWER SWITCH.
- ③ Turn the VOLUME CONTROL clockwise for a comfortable receive volume.
- ④ Push the TUNE SWITCH to allow your external automatic antenna tuner (optional) to tune the antenna for the selected frequency.
  - The TUNE SWITCH does not function if there is no antenna tuner connected.
  - The TUNE INDICATOR on the front panel remains lit until the tuning is completed.
- ⑤ Turn ON the SQUELCH SWITCH to quiet the speaker noise when there is no signal being received on the chosen channel.
  - The RECEIVE INDICATOR goes out. When a signal appears on the chosen channel, it will be audible from the speaker, and the RECEIVE INDICATOR lights.
  - When receiving a weak signal, leave the SQUELCH SWITCH off.
- ⑥ Adjust the CLARITY CONTROL to obtain the clearest, most pleasing audio signal.
- ⑦ Turn ON the NOISE BLANKER when pulse noise, such as ignition noise, is present.
- ⑧ Pull OUT the VOLUME CONTROL when communicating with FSK to disconnect the internal speaker for quieter operation.
- ⑨ Push and release the DISPLAY SWITCH to turn the front panel indicator lights and frequency readout OFF.
  - For night operation, it may be better to leave this switch IN.

## 5 - 2 - 3 TRANSMITTING

### ■ USB (LSB) and AM OPERATION

- ① Set the front panel controls.
- ② Check for a clear frequency.
- ③ Transmit using either PTT or MANUAL operation.

### ■ CW OPERATION

- ① Use either FULL BREAK-IN or MANUAL operation.
- ② Set the front panel controls.
- ③ Plug a CW key into the rear panel.
- ④ Transmit.

### ■ FSK OPERATION

- ① Ascertain all internal FSK switches and controls are set correctly.
- ② Set the front panel controls.

The following section provides information for operation on any of the available modes: USB (LSB), AM, CW or FSK.

- ① First, adjust the IC-M700TY as described in SECTION 5 - 2 - 2 RECEIVING.
- ② Before transmitting, listen in the receive mode to make sure the frequency is clear.
  - When the transmit frequency differs from the receive frequency on the channel you intend to operate on, push and hold the TRANSMIT FREQUENCY/RESET SWITCH to listen on the transmit frequency. Release the switch when certain your transmit frequency is clear.

- ③ There are two methods for transmitting when operating USB (LSB) or AM.

#### PTT:

- Push the PTT (push-to-talk) SWITCH on the microphone and speak into the microphone in a normal voice.
- Release the PTT SWITCH to return to the receive mode.

#### MANUAL:

- Place the T/R SWITCH on the front panel to the TX (up) position and speak into the microphone in a normal voice.
- Place the T/R SWITCH at the RECEIVE (center) position to return to the receive mode.

- ① Refer to SECTION 3 - 10 CW SETTINGS for information on how to select either the FULL BREAK-IN or MANUAL mode for CW operation.

- ② Adjust the IC-M700TY as described in SECTION 5 - 2 - 2 RECEIVING.

- ③ Plug a CW key into the CW KEY JACK on the rear panel of the IC-M700TY.

- ④ There are two methods for transmitting when operating CW.

#### FULL BREAK-IN:

This method closely simulates full duplex operation since the transmitter is turned on automatically only when the CW key contacts are actually closed. Otherwise, the transceiver remains in the receive mode.

- Send normally with the CW key. The IC-M700TY will switch between transmit and receive automatically.

#### MANUAL:

- Move the front panel T/R SWITCH to the TRANSMIT (up) position and begin sending with the CW key.
- Move the T/R SWITCH to the RECEIVE (center) position when finished transmitting.

- ① Refer to SECTION 3 - 8 ACCESSORY CONNECTORS for connection information for FSK operation and SECTION 3 - 11 FSK SETTINGS.

**NOTE:** The IC-M700TY is shipped ready for use with the standard 170Hz shift frequency.

- ② Adjust the IC-M700TY as described in SECTION 5 - 2 - 2 RECEIVING.



③ Transmit.

④ Pull OUT the VOLUME CONTROL for quieter operation.

③ The IC-M700TY may be operated at full output power, however, should the temperature of the PA unit become excessively high for any reason, the output power is automatically reduced to 60 watts. When the PA unit has cooled, full output power is automatically resumed.

④ Pull OUT the VOLUME CONTROL to disconnect the internal speaker for more pleasant operation.

### 5-3 ALARM FUNCTION

#### ■ TESTING THE ALARM FUNCTION

① Push the ALARM SWITCH.

② Push the ALARM SWITCH again to stop the tones.

③ Reset the IC-M700TY.

#### ■ TRANSMITTING ALARM SIGNALS

**CAUTION:** Never transmit alarm signals except when you require emergency assistance.

① Hold the T/R SWITCH at TX ALARM, and push the ALARM SWITCH.

② Alarm signals are transmitted.

③ Transmit emergency messages.

④ Reset the IC-M700TY.

⑤ Select other modes of operation on 2182.0kHz as required.

The alarm unit is supplied as a standard feature in the IC-M700TY. This unit transmits an internationally recognized distress signal on the frequency of 2182kHz.

① With the IC-M700TY in the receive mode, push the ALARM SWITCH.

- The operating frequency is set to 2182.0kHz and the mode to AM, even if a different frequency and mode have been set previously. The 10MHz decimal point indicates this.
- Alarm signal tones can be heard from the speaker and the ALARM INDICATOR on the front panel lights.
- The tones continue for approximately 50 seconds.

② Push the ALARM SWITCH again to stop the tones.

③ Push the TRANSMIT FREQUENCY/RESET SWITCH to clear the alarm function.

- The IC-M700TY returns to the previous operating frequency and mode.

① Push the ALARM SWITCH while holding the T/R SWITCH down in the TX ALARM position.

- The operating frequency is set to 2182.0kHz and the AM mode is automatically selected, even if a different frequency and mode have been set previously.
- The 10MHz decimal point also illuminates to indicate the mode and power have been automatically set as stated above.
- Alarm signals are transmitted, alarm tones are heard from the speaker and the ALARM and TRANSMIT INDICATOR on the front panel light.
- The tones continue for approximately 50 seconds.

② When an antenna tuner is connected:

- The IC-M700TY first enters the antenna tuning mode.
- When the antenna system is tuned on 2182kHz the IC-M700TY changes to the transmit mode automatically and transmits the alarm signals.
- After approximately 50 seconds, the IC-M700TY returns to the receive mode. The emergency frequency (2182kHz) and mode (AM) are maintained.

③ Depress the PTT SWITCH on the microphone to transmit distress messages.

- Speak in a normal, clear voice.

④ Push the TRANSMIT FREQUENCY/RESET SWITCH to clear the alarm function.

- The transceiver returns to the previous operating frequency and mode.

⑤ To operate on 2182.0kHz using a mode other than AM:

- Select the "2182" position with the CHANNEL GROUP SWITCH.
- Push the TRANSMIT FREQUENCY/RESET SWITCH (the 10MHz decimal point goes out) and select the desired mode with the MODE SWITCH.

# SECTION 6 BLOCK DIAGRAM

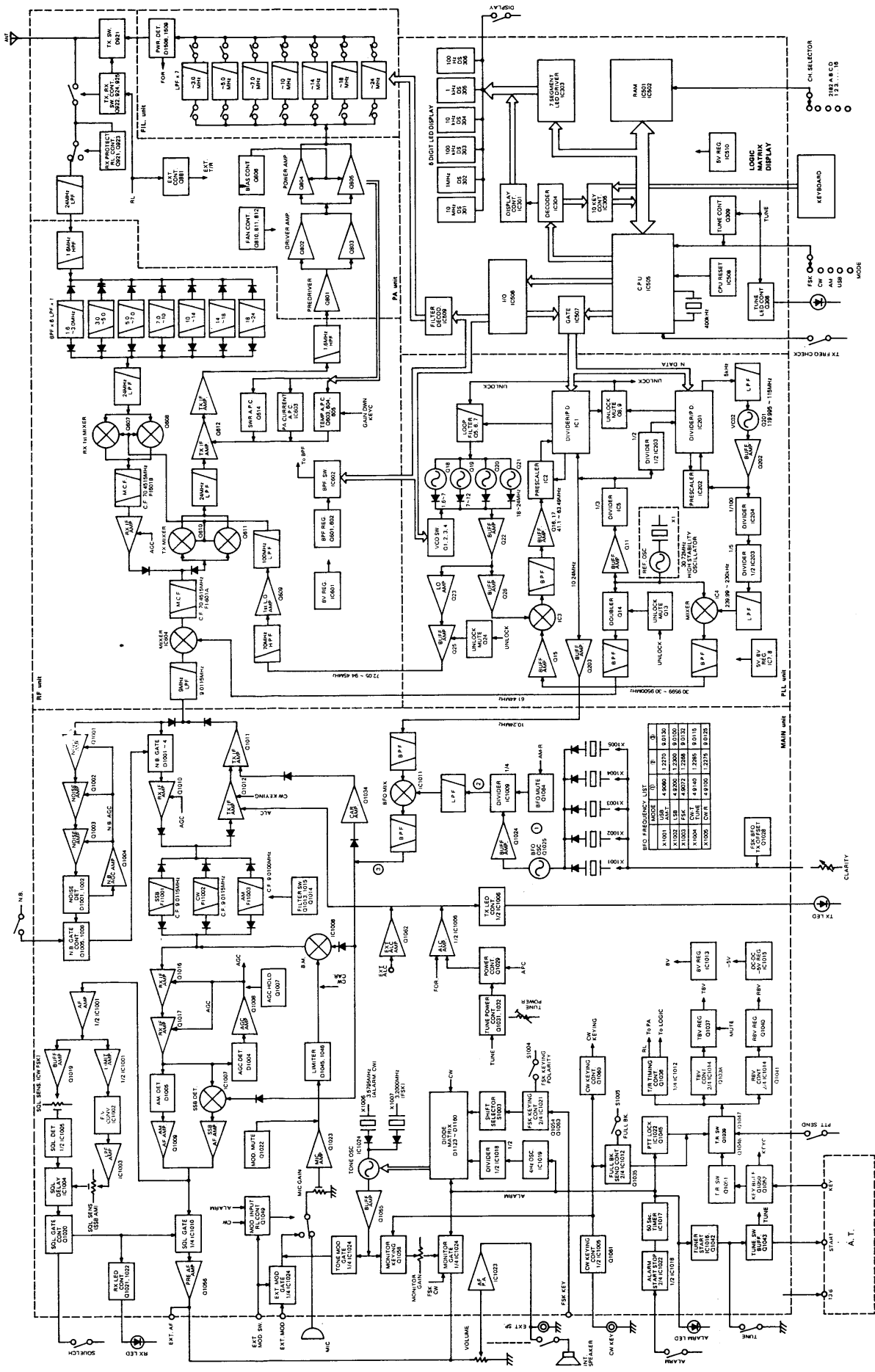

**SECTION 7 OPTIONS**

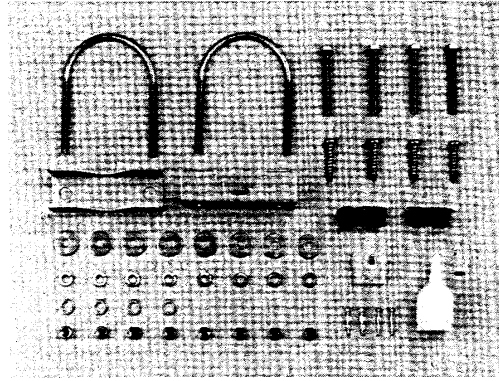
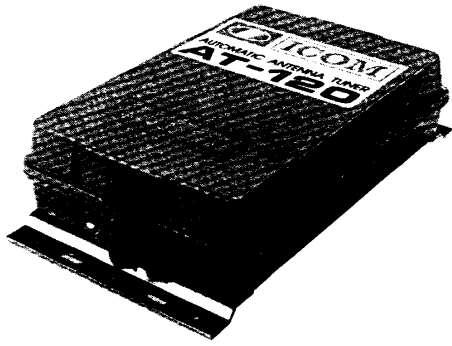

●AT-120 AUTOMATIC ANTENNA TUNER for maximum efficiency from your antenna system.

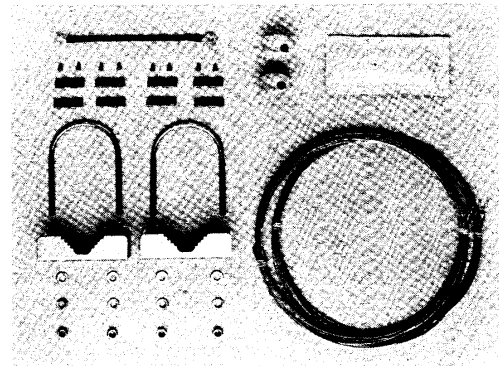
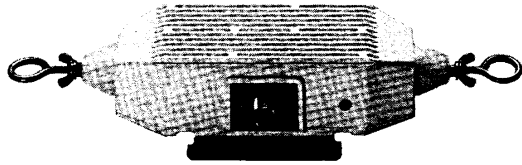

●MN-100 ANTENNA MATCHER for dipole or whip antennas.

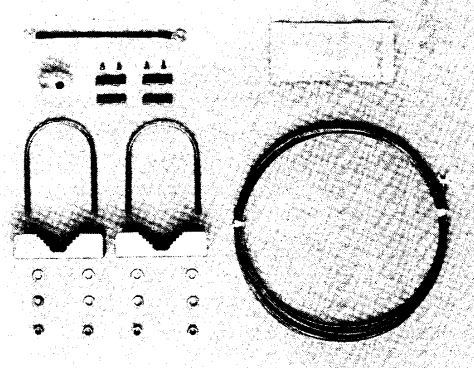
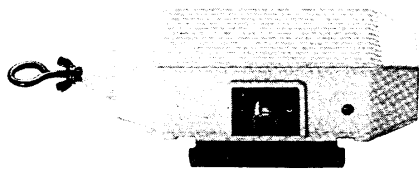

●MN-100L ANTENNA MATCHER for whip or long wire antennas.

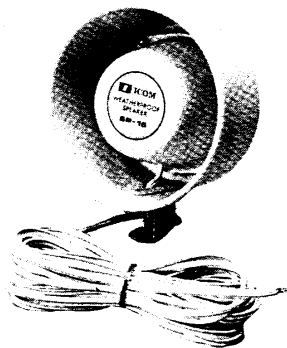

●SP-15 EXTERNAL SPEAKER

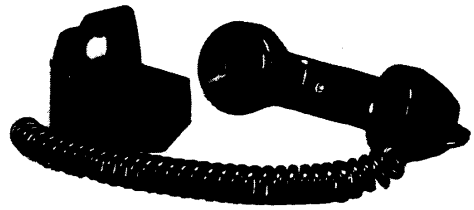

●IC-HS2 TELEPHONE HANDSET  
for extra privacy



**ICOM INCORPORATED**  
1-6-19, KAMIKURATSUKURI, HIRANO-KU,  
OSAKA 547, JAPAN

A-0734  
Printed in Japan